

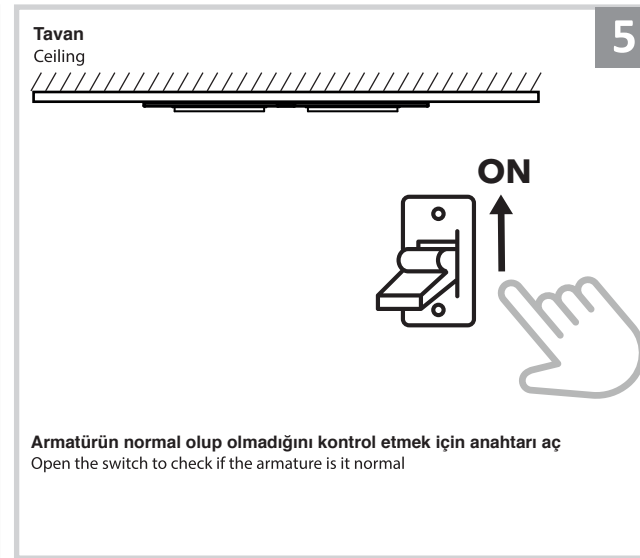

Sıva Altı Armatür İçin Montaj ve Kullanım Kılavuzu

Assembly and Application Manual For Recessed Armature

MD 119-2-100

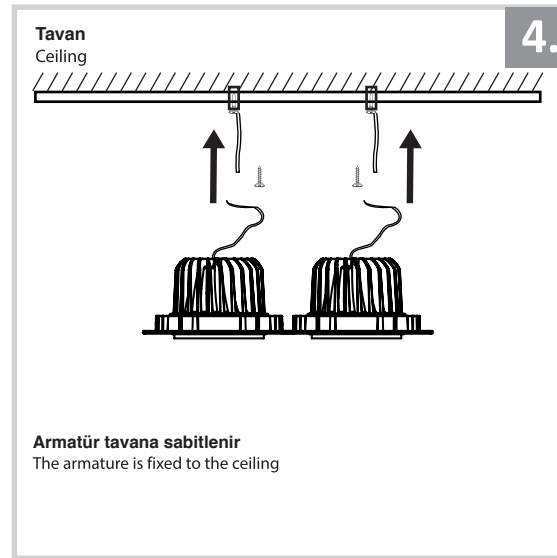
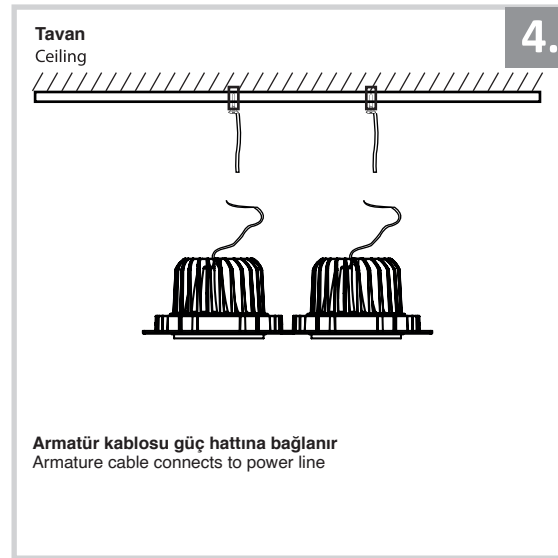
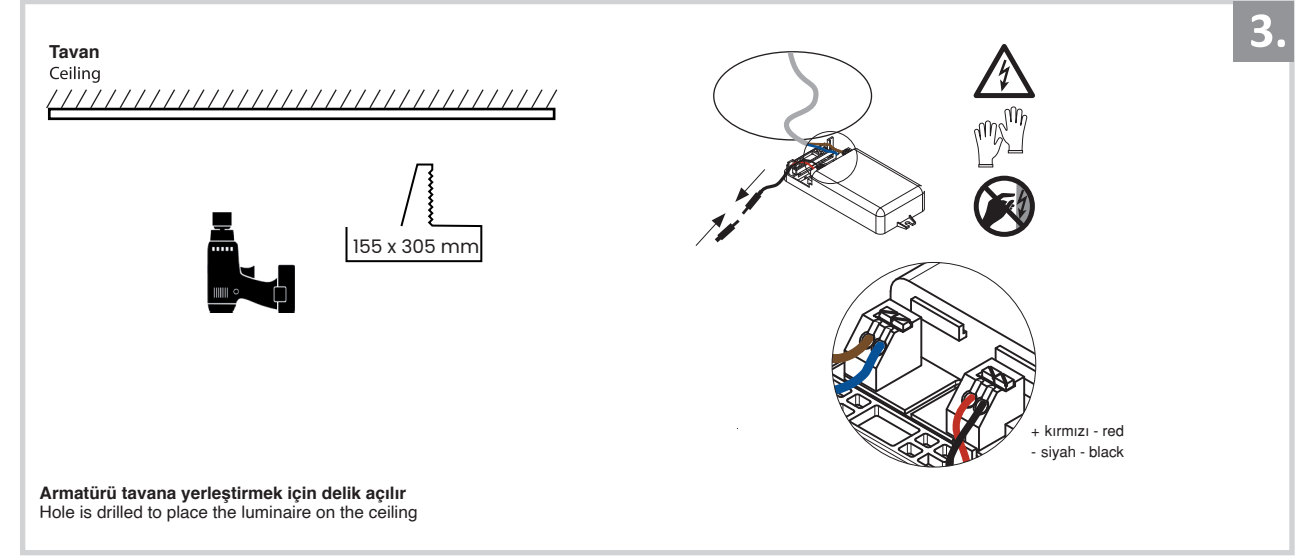
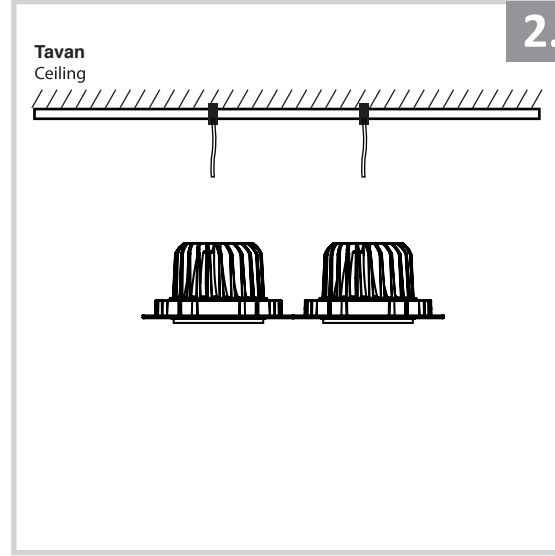
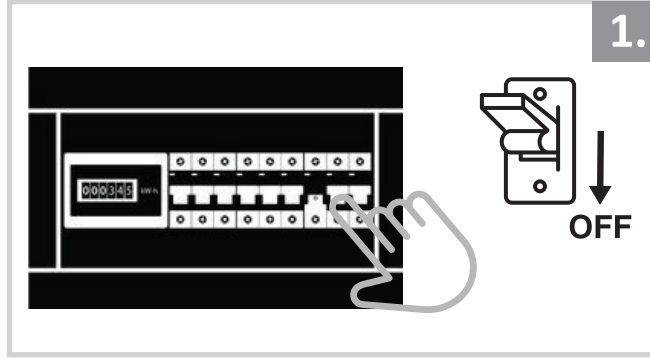

UYARI !!!!
HERHANGİ BİR ÜRÜNÜ VEYA ELEKTRİKLİ AYGITI BAĞLAMADAN VEYA SÖKMEYEN ÖNCE MUTLAKA KAT SİGORTASINI VEYA ANA SİGORTAYI KAPATMAYI UNUTMAYIN VE DOĞRU SİGORTAYI KAPATTIĞINIZDAN EMİN OLUN.
Eğer bu ürünün bağlantısını yapabileceğinizden emin değilseniz mutlaka deneyimli bir elektrikçiye başvurun. Elektrik konusu hayati önem taşır.

WARNING !!!!
WITHOUT CONNECTING ANY PRODUCT OR ELECTRICALLY EQUIPMENT OR DO NOT ALWAYS CLOSE FLOOR INSURANCE OR MAIN INSURANCE BEFORE YOU REMOVE DO NOT REMEMBER AND MAKE SURE YOU FOLLOW YOUR FIRST INSURANCE.
If you are not sure that you can connect this product, Please contact the electrician. Electricity is of vital importance.