



Ray Spot Armatür İçin Montaj ve Kullanım Kılavuzu

Assembly and Application Manual For Track Spot Armature

MR 1030-85

masialux
LIGHTING DESIGN

TR www.masialux.com
+90 212 434 00 00

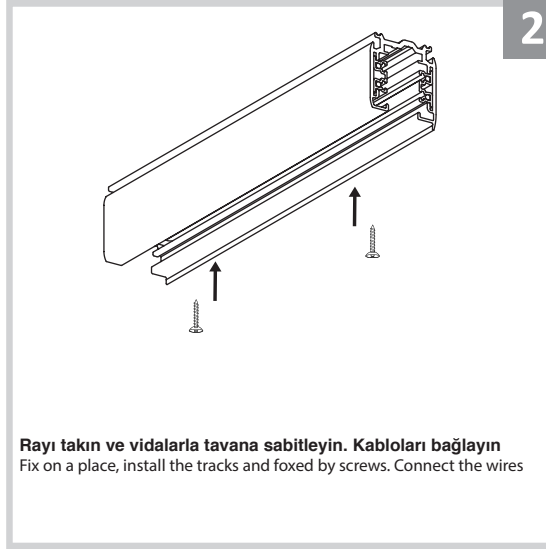
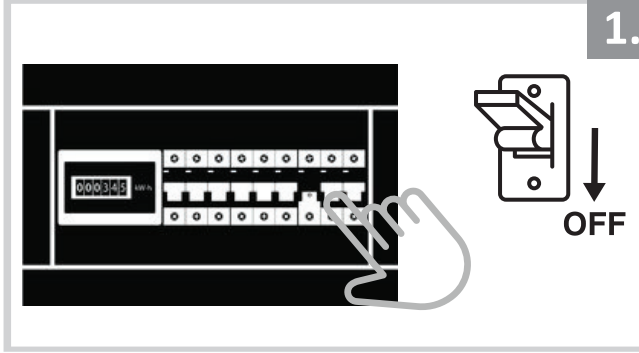

Rayı takın ve vidalarla tavana sabitleyin. Kabloları bağlayın
Fix on a place, install the tracks and foxed by screws. Connect the wires

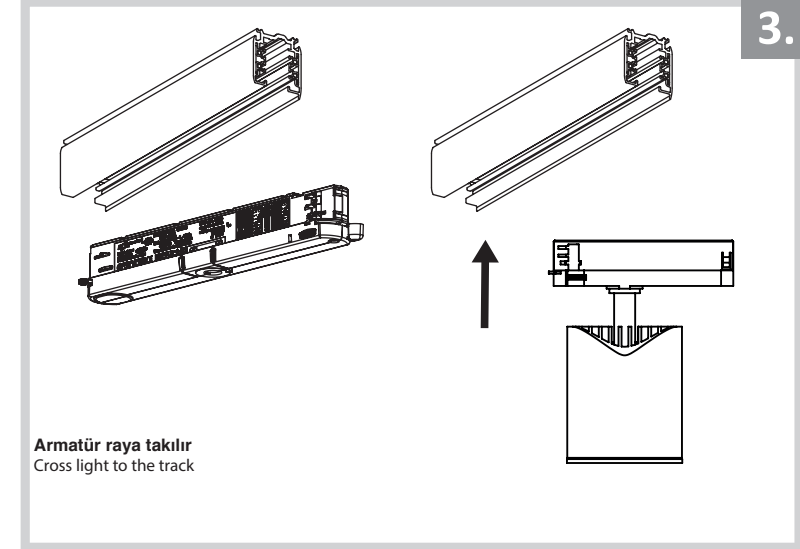

Armatür raya takılır
Cross light to the track

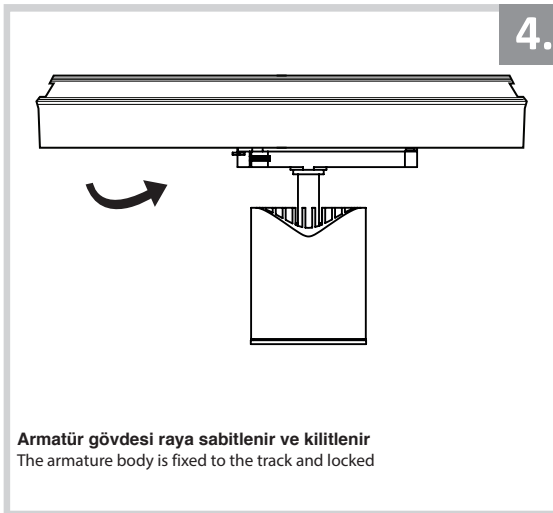

Armatür gövdesi raya sabitlenir ve kilitletir
The armature body is fixed to the track and locked

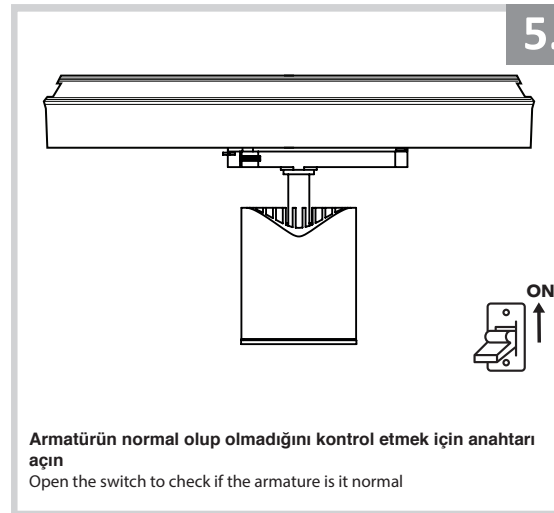

Armatürün normal olup olmadığını kontrol etmek için anahtarı açın
Open the switch to check if the armature is it normal



UYARI !!!!

HERHANGİ BİR ÜRÜNÜ VEYA ELEKTRİKLİ AYGITI BAĞLAMADAN VEYA SÖKMEYEN ÖNCE MUTLAKA KAT SİGORTASINI VEYA ANA SİGORTAYI KAPATMAYI UNUTMAYIN VE DOĞRU SİGORTAYI KAPATTIĞINIZDAN EMİN OLUN.
Eğer bu ürünün bağlantısını yapabileceğinizden emin değilseniz mutlaka deneyimli bir elektrikçiye başvurun. Elektrik konusu hayati önem taşır.

WARNING !!!!

WITHOUT CONNECTING ANY PRODUCT OR ELECTRICALLY EQUIPMENT OR DO NOT ALWAYS CLOSE FLOOR INSURANCE OR MAIN INSURANCE BEFORE YOU REMOVE DO NOT REMEMBER AND MAKE SURE YOU FOLLOW YOUR FIRST INSURANCE.
If you are not sure that you can connect this product, Please contact the electrician. Electricity is of vital importance.