



## Ray Spot Armatür İçin Montaj ve Kullanım Kılavuzu

Assembly and Application Manual For Track Spot Armature

MR 421

**masialux**  
LIGHTING DESIGN

TR [www.masialux.com](http://www.masialux.com)  
+90 212 434 00 00

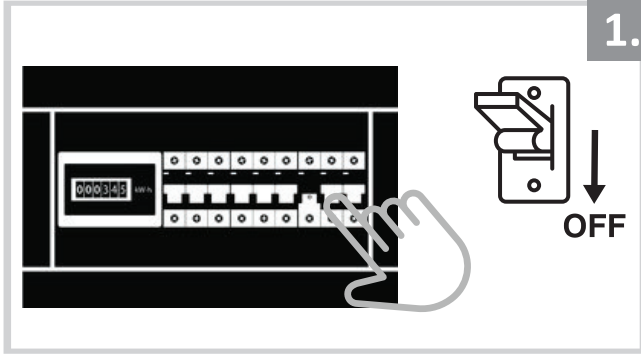

Rayı takın ve vidalarla tavana sabitleyin. Kabloları bağlayın  
Fix on a place, install the tracks and foxed by screws. Connect the wires

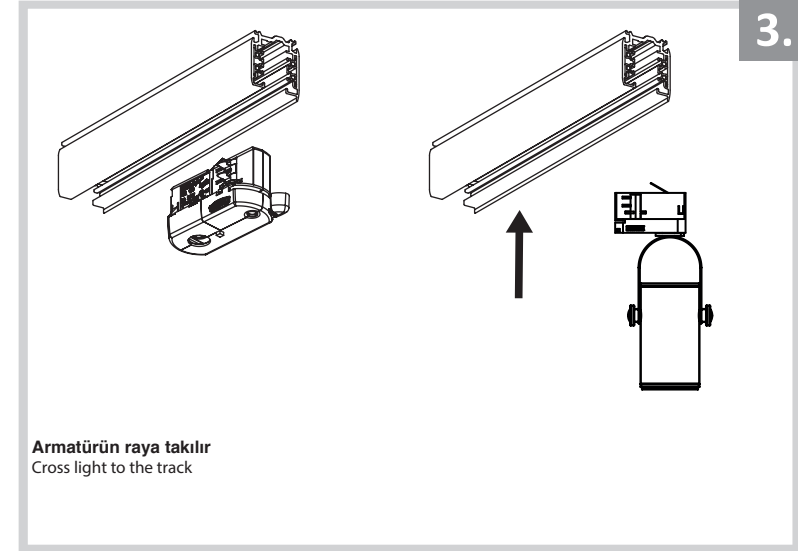

Armatürün raya takılır  
Cross light to the track

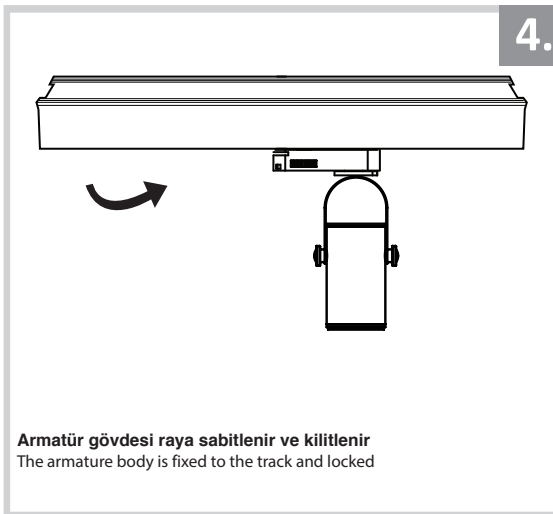

Armatür gövdesi raya sabitlenir ve kilitletir  
The armature body is fixed to the track and locked

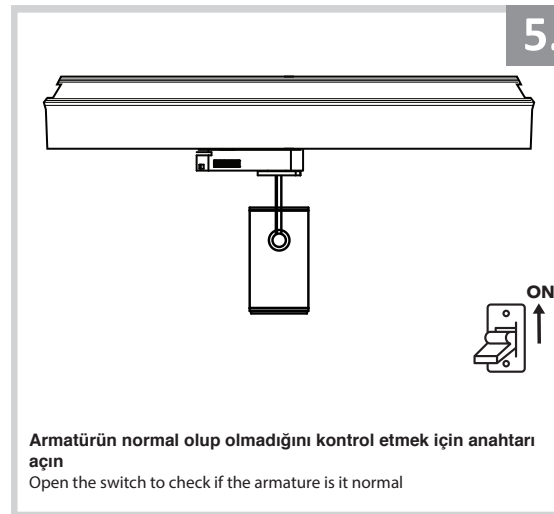

Armatürün normal olup olmadığını kontrol etmek için anahtarı açın  
Open the switch to check if the armature is it normal



### UYARI !!!!

HERHANGİ BİR ÜRÜNÜ VEYA ELEKTRİKLİ AYGITI BAĞLAMADAN VEYA SÖKMEDEN ÖNCE MUTLAKA KAT SİGORTASINI VEYA ANA SİGORTAYI KAPATMAYI UNUTMAYIN VE DOĞRU SİGORTAYI KAPATTIĞINIZDAN EMİN OLUN.  
Eğer bu ürünün bağlantısını yapabileceğinizden emin değilseniz mutlaka deneyimli bir elektrikçiye başvurun. Elektrik konusu hayati önem taşır.

### WARNING !!!!

WITHOUT CONNECTING ANY PRODUCT OR ELECTRICALLY EQUIPMENT OR DO NOT ALWAYS CLOSE FLOOR INSURANCE OR MAIN INSURANCE BEFORE YOU REMOVE DO NOT REMEMBER AND MAKE SURE YOU FOLLOW YOUR FIRST INSURANCE.  
If you are not sure that you can connect this product, Please contact the electrician. Electricity is of vital importance.