



Sıva Üstü Sarkıt Linear Armatür İçin Montaj ve Kullanım Kılavuzu

Assembly and Application Manual For Surface Mounted Pendant Linear Armature

MS 660

masialux
LIGHTING DESIGN

TR www.masialux.com
+90 212 434 00 00

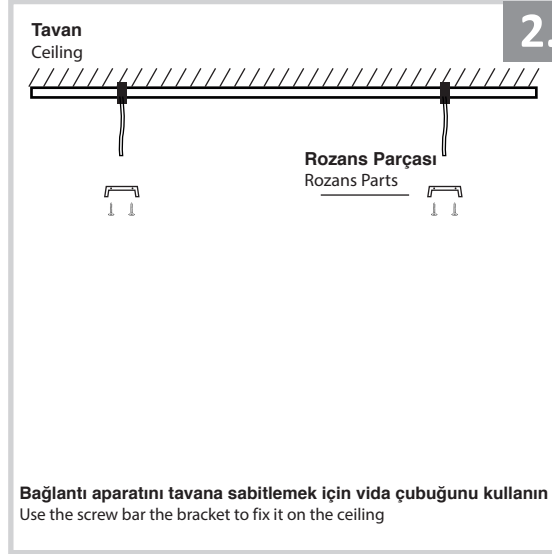
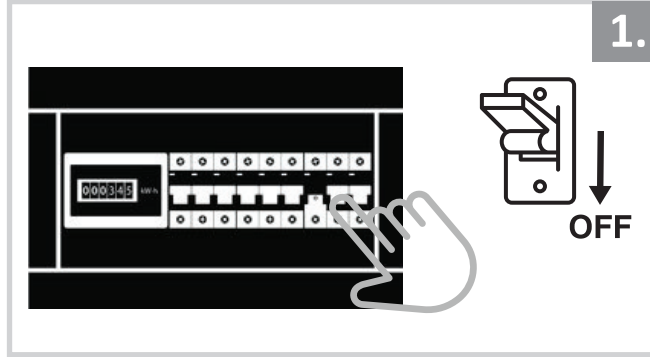

Bağlantı aparatını tavana sabitlemek için vida çubuğunu kullanın
Use the screw bar the bracket to fix it on the ceiling

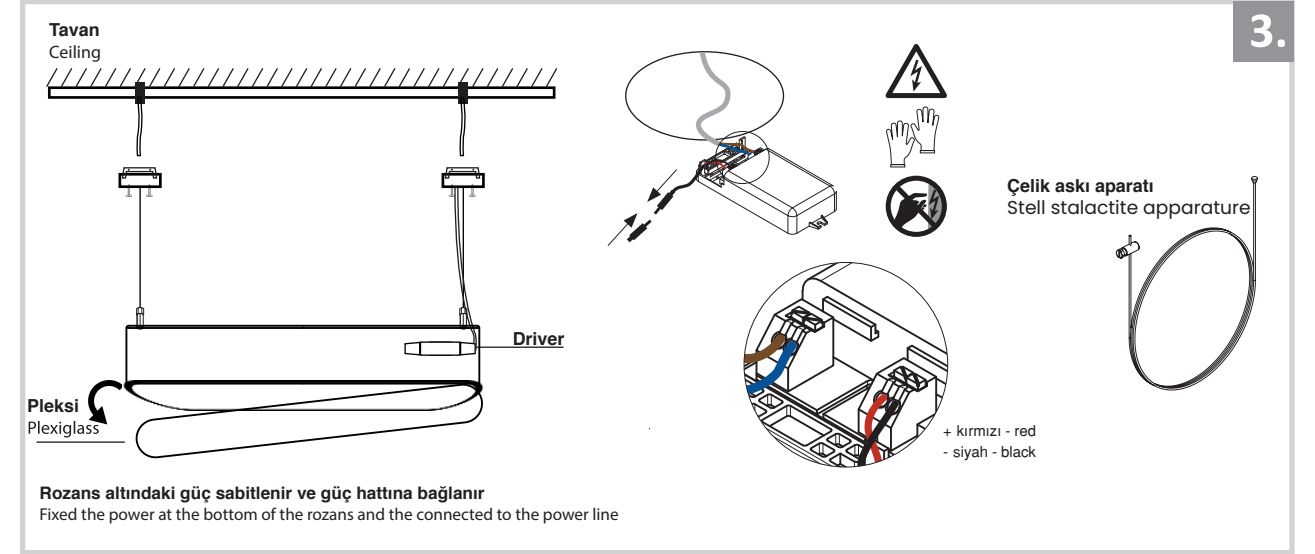

Rozans altındaki güç sabitlenir ve güç hattına bağlanır
Fixed the power at the bottom of the rozans and the connected to the power line

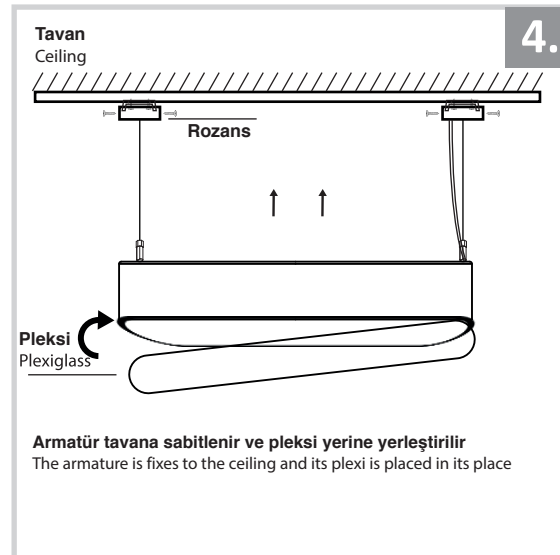

Armatür tavana sabitlenir ve pleksi yerine yerleştirilir
The armature is fixes to the ceiling and its plexi is placed in its place

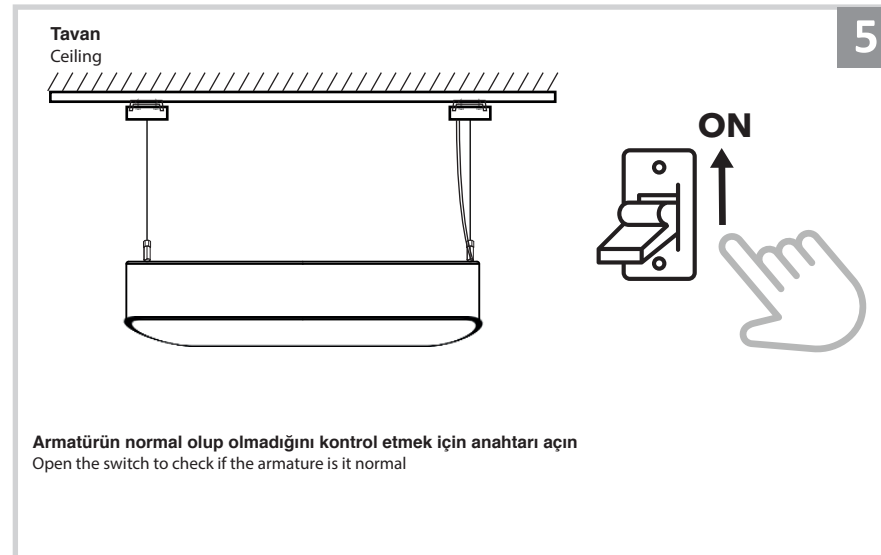

Armatürün normal olup olmadığını kontrol etmek için anahtarı açın
Open the switch to check if the armature is it normal



UYARI !!!!

HERHANGİ BİR ÜRÜNÜ VEYA ELEKTRİKLİ AYGITI BAĞLAMADAN VEYA SÖKMEDEN ÖNCE MUTLAKA KAT SİGORTASINI VEYA ANA SİGORTAYI KAPATMAYI UNUTMAYIN VE DOĞRU SİGORTAYI KAPATTIĞINIZDAN EMİN OLUN. Eğer bu ürünün bağlantısını yapabileceğinizden emin değilseniz mutlaka deneyimli bir elektrikçiye başvurun. Elektrik konusu hayatı önem taşır.

WARNING !!!!

WITHOUT CONNECTING ANY PRODUCT OR ELECTRICALLY EQUIPMENT OR DO NOT ALWAYS CLOSE FLOOR INSURANCE OR MAIN INSURANCE BEFORE YOU REMOVE DO NOT REMEMBER AND MAKE SURE YOU FOLLOW YOUR FIRST INSURANCE. If you are not sure that you can connect this product, Please contact the electrician. Electricity is of vital importance.